



NOISETTE

Assembly and Owner's Manual

OPTICAL THEREMIN



ZEPPELINDESIGNLABS.COM • 920 W. WILSON, CHICAGO, IL 60640

NOISETTE OPTICAL THEREMIN

Assembly Manual

INTRODUCTION	3
HOW IT WORKS	4
WHAT YOU WILL NEED	5
TOOLS	5
SUPPLIES	5
WHAT'S IN THE BOX.....	6
POPULATING THE PRINTED CIRCUIT BOARD.....	8
USING YOUR NOISETTE	26
PLAYING YOUR NOISETTE	28
SCHEMATIC.....	29



INTRODUCTION

The Noisette is our take on a classic electronic musical instrument developed by the famous Russian physicist Leon Theremin. The original circuit was stumbled upon by accident when Mr. Theremin was developing a device that used radio waves to detect the density of different gases. To keep from having to look at a meter while using this device, he added an audio amplifier and a speaker to this circuit as to give an audible representation of the density of the gas being measured. In working on this circuit, Leon found that his natural body capacitance altered some of its electrical parameters, causing the audible pitch to rise and fall depending on how close he was to the circuit. This was such a novel and unique discovery that he continued to develop the circuit and eventually turned it into the very first electronic musical instrument that we all know as the Theremin, which also had the unique distinction of being the first instrument that a person played without touching it.

Of course, this original circuit was made with vacuum tubes causing it to be big and bulky. Over the years, with the advancement of technology, circuit designers have tweaked and modified the original Theremin circuit to use transistors and other solid state components to reduce its size and cost. We have taken this approach a step further by replacing the bulky capacitive sensing antennas with light sensors, all while keeping the traditional circuit topology intact, along with the basic principle of being a touchless instrument.

The Theremin is one of the world's most unique instruments, being able to create spooky and other-worldly sounds, all while not being touched! Even so, the popularity of the Theremin has fluctuated over the years, but it has always had a passionate fan-base keeping it alive and in the public consciousness. This passion for the Theremin has earned it a legendary status in the electronic music community around the world. We here at Zeppelin Design Labs are very proud to be part of this legacy by bringing you our modern take on this classic instrument. We sincerely hope you have as much fun building and playing the Noisette as we did in designing it!



HOW IT WORKS

In general, Theremin circuits have two inputs: a pitch sensor, and a volume sensor. The pitch sensor controls a circuit known as a voltage controlled oscillator (VCO), which generates the Theremin's audio signal. The volume sensor controls a circuit called a voltage controlled amplifier (VCA) which alters the amplitude (or volume) of the audio signal that was generated by the VCO.

The Noisette circuit topology is basically the same as the original Theremin circuit. We are just using a few modern components to obtain the same result. One of the main differences is instead of vacuum tubes like in the original circuit, we are using integrated circuits (ICs, aka microchips) in the VCO and VCA circuits.

The original Theremin circuit used capacitive sensitive antennas as its sensors. The Noisette uses light detection sensors, known as LDRs (light dependent resistors) to determine the pitch and volume of the audio. LDRs have a very large resistance across their pins in the dark, but the resistance drops very low when light shines on them. For the pitch and volume sensors, we are using these LDRs in a voltage divider circuit to obtain a variable voltage depending on how much light they detect. The Noisette's VCA also contains an LDR optocoupler. This optocoupler allows us to control the volume of the audio through an LDR controlled by a light emitting diode (LED), the brightness of which is controlled by the volume sensor circuit. The brighter the LED gets, the less resistance the LDR has, causing the audio to get louder.

Figure 1 shows a block diagram of the Noisette circuit, to help visualize how it works.

Figure 1: Noisette Block Diagram

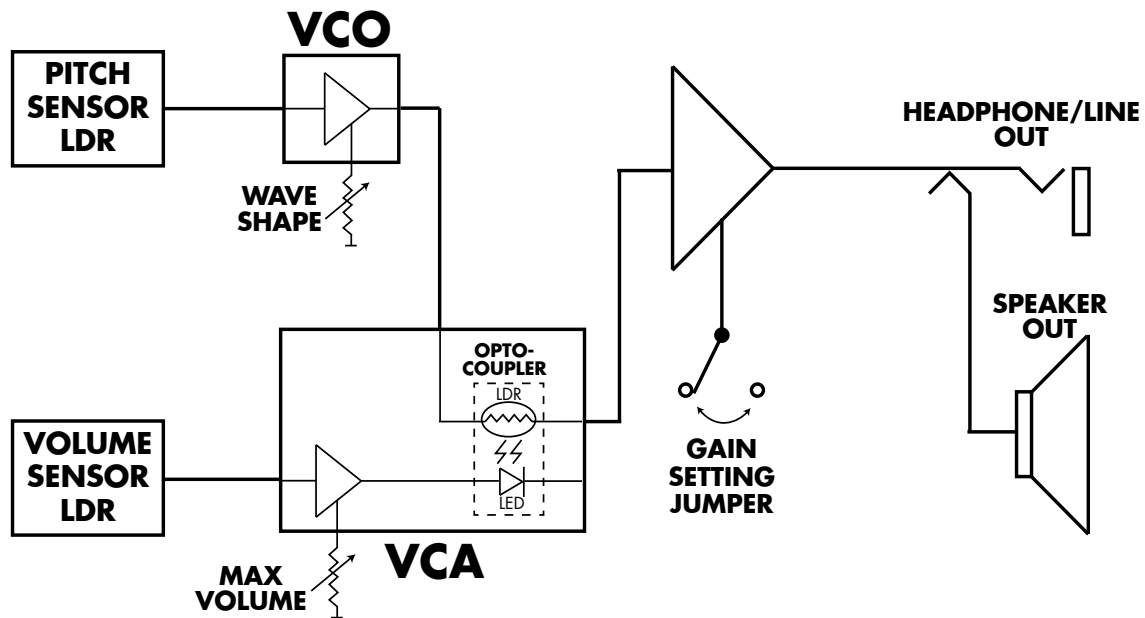

WHAT YOU WILL NEED

Here's everything you will need to build your Noisette Optical Theremin kit as shown below:

TOOLS

1. #2 Phillips screwdriver
2. Tiny (precision) flathead screwdriver for adjusting the trimmer potentiometers
3. Soldering iron (not a soldering gun, or a cold heat iron), good quality, 15-50 watt, with a good medium or small-sized tip, conical or chisel shape. One with a temperature control and a stand is best.*
4. Damp sponge to clean your soldering iron
5. Wire strippers*
6. Flush cutters or small diagonal cutters*
7. Clamp or vise to hold the printed circuit board while soldering (optional, but handy)
8. Solder sucker and/or solder braid (optional, but very handy if you have to remove or repair any components!)
9. Ruler
10. Digital multimeter*
11. Needle nose pliers
12. Hot glue gun (as an alternative to super glue, see supplies)

SUPPLIES

1. Solder, 60/40 rosin core, the smaller diameter the better (we prefer .032" diameter). Make sure it's good quality. We prefer Kester brand, but most brands will work fine.
2. Super glue gel (thick CA glue), or hot a glue stick to be used with your hot glue gun, if you don't use super glue gel.
3. 9 volt battery (if not using a 9 volt wall adapter)

* Available from the Zeppelin Design Labs webstore.

WHAT'S IN THE BOX

Table 1: The Noisette Optical Theremin Bill of Materials (BOM) is a complete parts list of everything that should be present in your kit, followed by photos of each part. Carefully go through the kit, identifying every part. Please read about the proper handling of integrated circuits (ICs) in paragraph 7 on page 18 before removing the circuit board from the silver static-protective bag. Note that some of the components are difficult to tell apart. Compare them carefully with the photos. Besides verifying that nothing is missing, this will acquaint you with the parts and their names. If ANYTHING is missing, first double-check; we double-checked before sealing the bag at our lab! If it's still missing, EMAIL US right away at info@zeppelinlabs.com. If we goofed and shorted your kit, we will get replacement parts in the mail to you as soon as possible. If you lose or damage anything, we will be glad to sell you replacements if we have them in stock. The unusual or custom components can be ordered directly from us (contact info@zeppelinlabs.com). For more common parts, like resistors, capacitors, or screws, you may prefer to go to a local electronics or hardware store.

Figure 2: What's in the Box

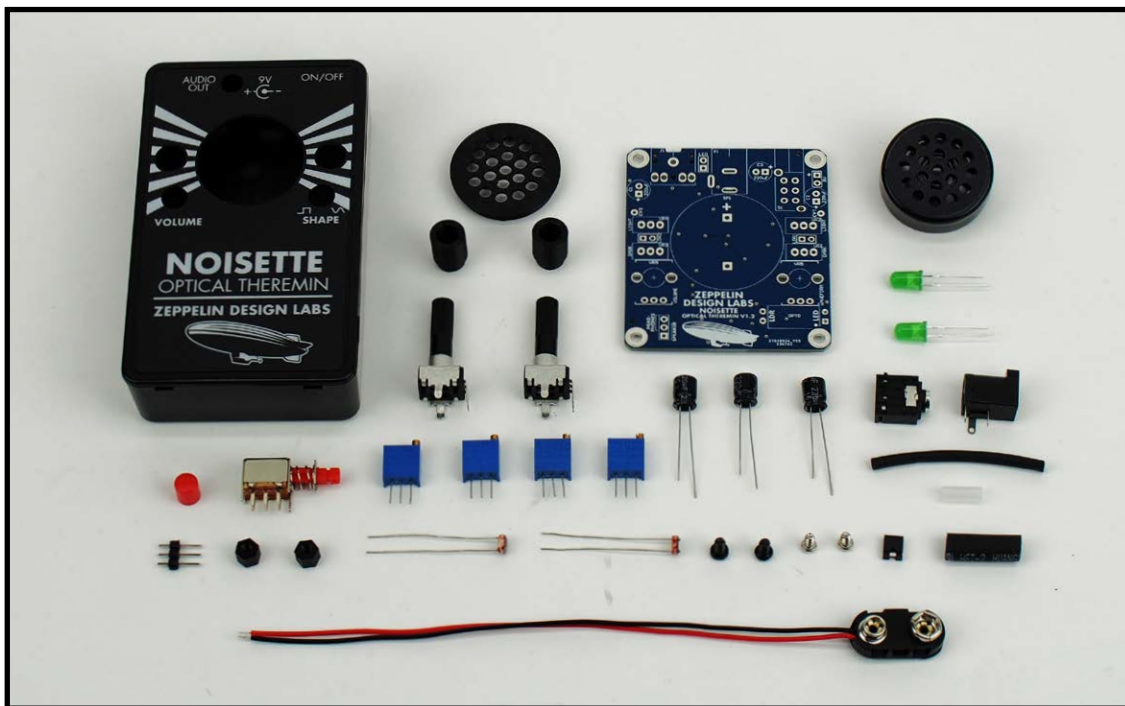
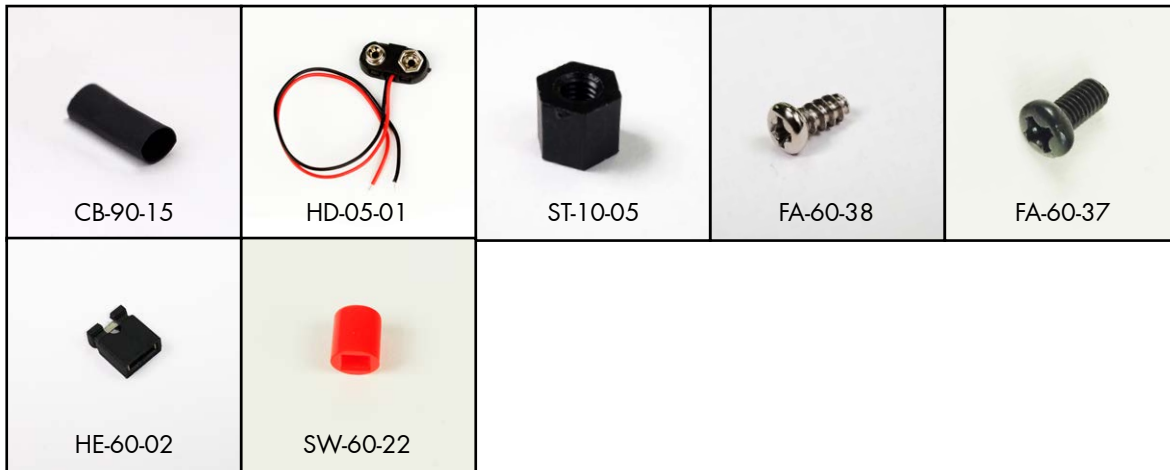

Table 1: The Noisette Optical Therman Bill of Materials (BOM)

Part #	Description	Notes	Qty
CA-30-20	Speaker Grille Cover		1
ST-50-20	LDR Shield		2
PC-78-01	Noisette Circuit Board		1
ST-60-20	Nylon LED Standoff		1
DI-30-52	Green 5mm LED		2
SW-50-30	Pushbutton DPDT Switch		1
HD-40-40	1/8" TRS Audio Jack		1
HD-40-10	DC Power Jack		1
LS-30-32	1" 32 Ohm Loudspeaker		1
CP-10-08	Electrolytic Capacitor 16V 220uF	C1, C2, C3	3
HE-20-01	Single Row Header	3 PIN	1
PT-30-30	Trim Potentiometer 100K		4
PT-10-10	9mm Potentiometer 100K		2
SN-30-10	LDR Sensor		3
CB-90-09	Heat Shrink Tubing (2mm x 42mm)		1
CB-90-15	Heat Shrink Tubing (5mm x 19mm)		1
HD-05-01	9V Battery Snap		1
ST-10-05	Hex Nylon Standoff M3.5x5		2
FA-60-38	Course Thread Screw Phillips Pan M2.5x5		2
FA-60-37	Machine Screw Phillips Pan M3x6		2
HE-60-02	Header Jumper 2 pin		1
SW-60-22	Red Switch Cap		1





POPULATING THE PRINTED CIRCUIT BOARD

Your work space should be well-lit, well-ventilated, and disposable; that is, don't work on the nice dining room table! Work on a utility surface that you can burn, drill, and scratch. A piece of ¼" tempered masonite, or a chunk of MDF, makes an excellent surface if you don't have a utility work bench.

CAUTION: Solder fumes are not healthy for you. The fumes consist of vaporized flux, which might irritate your nose and lungs. You should work in a space where the air drifts away from you as you work, so fumes do not rise straight into your face.

CAUTION: Solder residue usually contains lead, which is poisonous if you ingest it. Do not breathe the fumes, do not eat the supplies, wash your hands after you handle solder, and sweep and wipe up your work space after EVERY USE.

Your Noisette Optical Theremin contains one printed circuit board (PCB). All of the components will be installed on the component side of the board, which is the side that has the part labels on it. The other side of the board is called the solder side, which, as the name implies, is the side on which the legs of the components are soldered. Proper technique for installing and soldering components to a circuit board is demonstrated through several great resources on Instructables and Youtube under the search "PCB soldering tutorial."

The general procedure consists of the following:

1. Install the part on the component side of the board, by threading the wire leads through the appropriate holes in the board. For your convenience, the board has silk screen outlines indicating where the components should be placed, along with text indicating the part number and the component value.
2. Hold the component in place with your finger and turn the board over.
3. Gently bend the leads out at about 45 degrees to keep the component from falling out of its holes.
4. Install all of one type of component, bending each of the leads as they are installed.

TIP: Empty the parts of the kit into a bowl, NOT onto the cluttered workbench, or onto the living room carpet! This will protect you from losing tiny parts.

5. Flip the board over solder-side-up, and solder all of the components in one pass.
6. Clip the leads off with small diagonal cutters, right at the solder joint.

When soldering the components in this kit, try to keep them from getting too hot. Most components have a temperature threshold that shouldn't be exceeded. As a rule of thumb don't keep your iron on any leg longer than two seconds, and make sure the component stays cool enough to touch. If you find you have a hard time keeping any component from getting too hot, just solder one leg at time and let the part cool off before proceeding to the next leg. It's a good idea to take your time with the assembly process to ensure nothing goes wrong.

You will notice that we have already installed several components on the solder-side of the PCB. These components are surface mounted, which are a little more difficult to solder than standard hole-through components (like what you will be soldering on the board). Some of the surface mounted components are sensitive to static electricity, meaning they can easily get damaged if they are exposed to moderately high voltages. Unfortunately (or fortunately), humans are not sensitive to static electricity at these levels; in fact, most people can't even feel a static discharge less than around 1000 volts! So it is easy to damage these components without even knowing it. Since these components are already soldered to the circuit board, they are less likely to be damaged by static discharge but it is still important to be mindful of these principles in handling them. When you handle the circuit board (before you take it out of its anti-static bag, and throughout the assembly process), make sure you are grounded, preferably by touching something grounded to the electrical mains like the metal chassis of a plugged-in amplifier, or a refrigerator. At the very least you should touch a large conductive object like a metal desk or a filing cabinet. With this information in mind, please proceed carefully.

Figure 3: Component Values and Locations

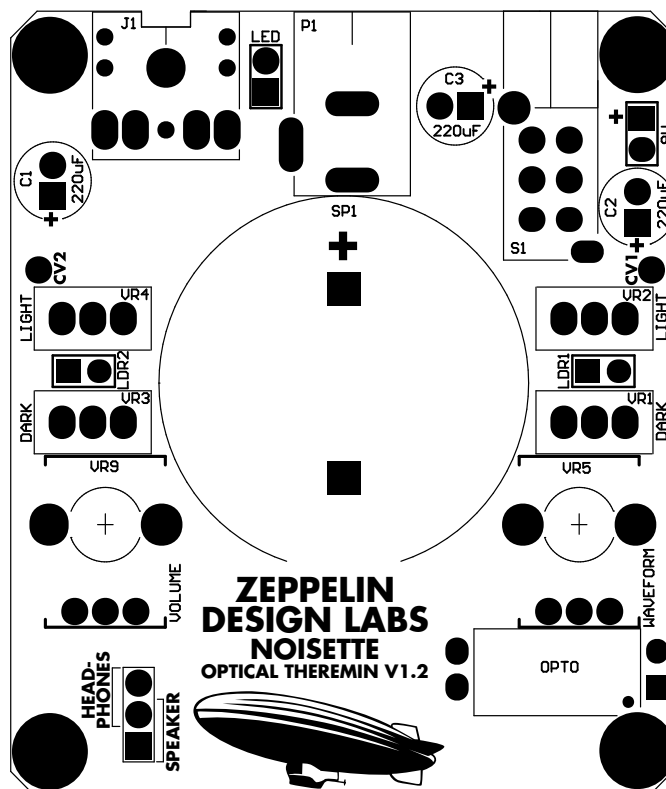

Let's begin!

1. 220uF Electrolytic Capacitors (C1, C2, C3): The first thing we'll install on your Noisette PCB are the capacitors. There are three electrolytic capacitors (aka "caps") in the Noisette. This type of capacitor IS POLARIZED: there is a right direction and a wrong direction to install them. If you get it wrong, they might burst. The white stripe on the case indicates the negative lead of the cap. Notice that one of the leads is longer than the other. The long lead on the capacitor is the positive lead (1).

STRIPE = NEGATIVE = SHORT LEAD = ROUND PAD

NO STRIPE = POSITIVE = LONG LEAD = SQUARE PAD

Make sure you orient this cap properly! For reference, the circuit board has a little plus sign(+) on the positive pads. Bend out the leads, as in the picture (3), to keep the components from falling out when you solder them. Flip the board over, solder and then snip all the leads close to the solder joint (4,5).

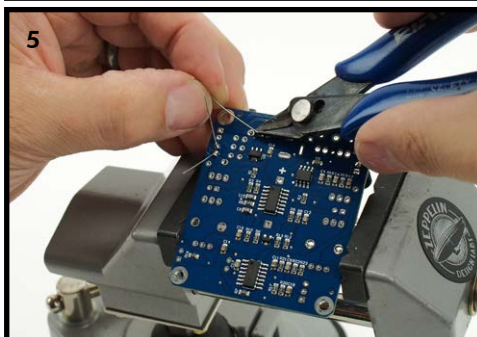
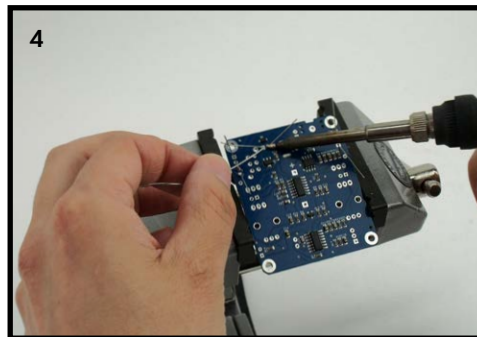
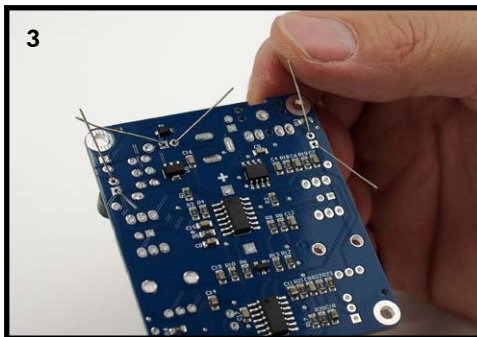
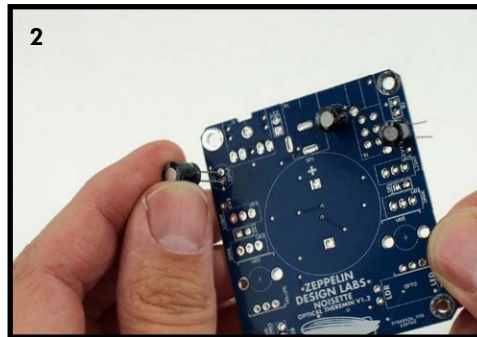
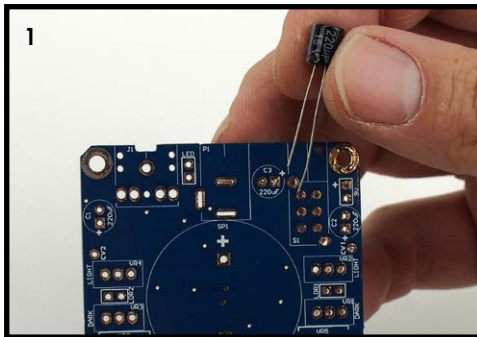

2. Headers: Your kit includes one 3-pin header. The process we use to solder these headers is to hold it in place with one finger, apply some solder to the tip of your iron, and then quickly tack in one lead on the bottom of the board (7). Make sure you don't hold down the pin that you are trying to tack down because the pin will heat up and it might burn you. Also make sure the bottom of the header is flush with the top of the board as this is done. Once one lead is held in place with the solder, we can put the circuit board in our clamp and solder the rest of the leads (8). Then we always re-solder the tacked-in lead to ensure it is making a good connection. Once the header is installed, place the jumper on the 2 pins labeled SPEAKER (9).

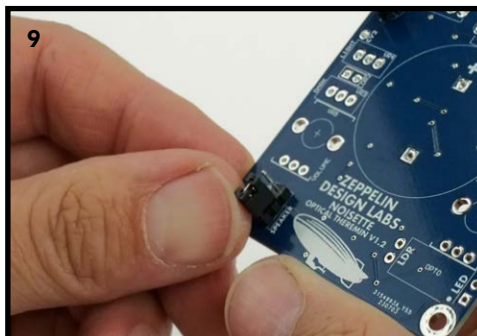
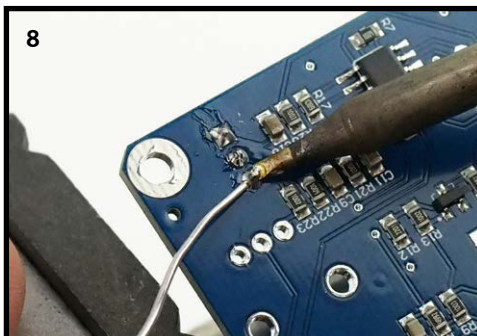
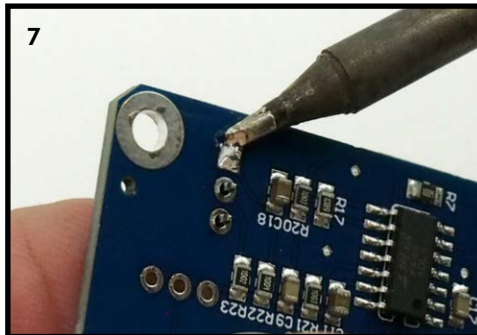
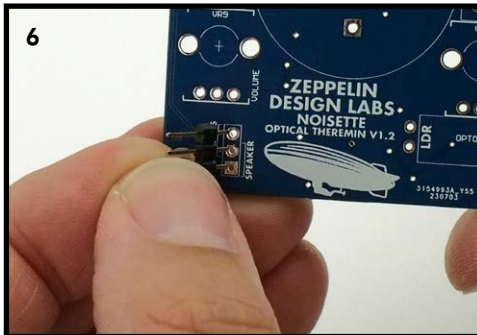

3. Power Light (LED): Place one of the green LEDs in the LED standoff (set the other LED aside for later). Feed the LED leads in through the open end of the standoff, and thread the leads through the two small holes in the other end. The green plastic body of the LED should be up against the open end of the standoff.

The LED is installed on the PCB in the spot marked LED, and it IS POLARIZED and must be installed in the correct orientation. If you get it backwards, the light won't work. The long lead goes into the hole with the square pad, the short lead goes into the round pad (12). Make sure the standoff is flush with the board and is standing straight up. Bend the leads out on the bottom (as you did with the caps) (13); flip the board over and solder and clip the leads (14,15).

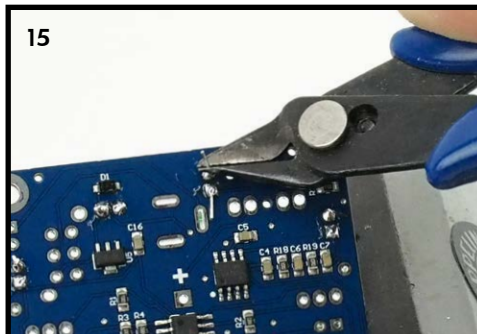
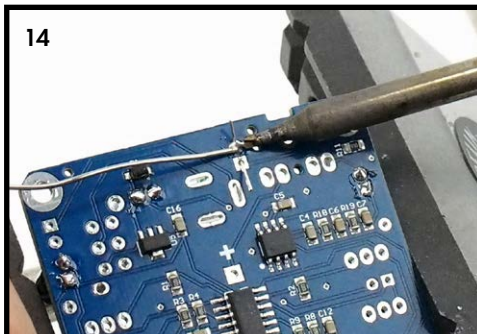
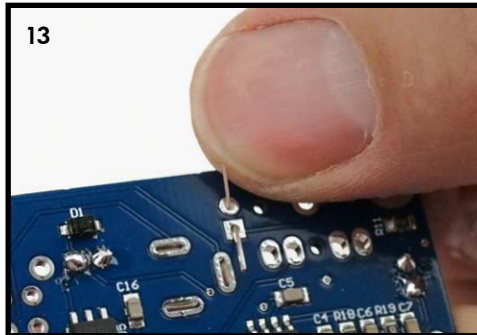
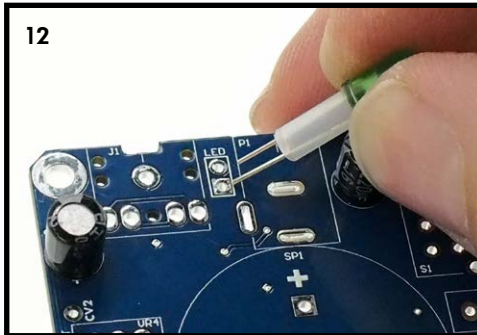
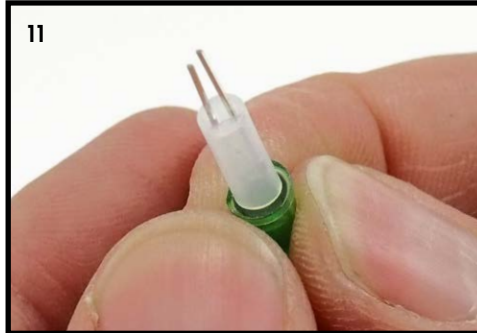
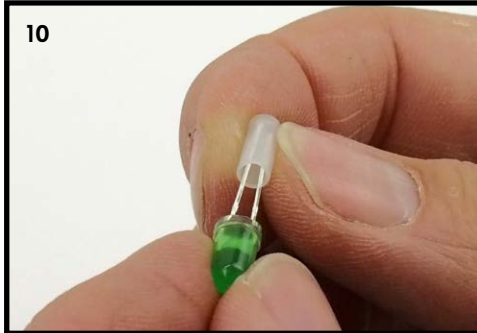

4. Power Switch: Before you place the power switch on the board, push the little red button cap all the way onto the switch (16). Press the switch snug to the board. Make sure the switch is sitting level (parallel) with the top of the circuit board (17). Flip the board over and solder the leads (18).

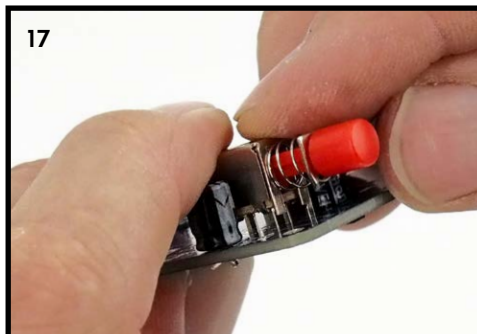

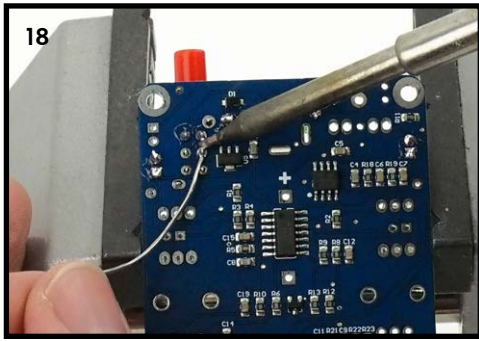

5. Power Jack: Press it snug to the board. Double check that it is sitting square to the front edge of the board and flush to the top of the board before you solder it. Tack one pin of the jack into place on the board while you hold it in (19). Once it's tacked in place, finish soldering it to the board (20).

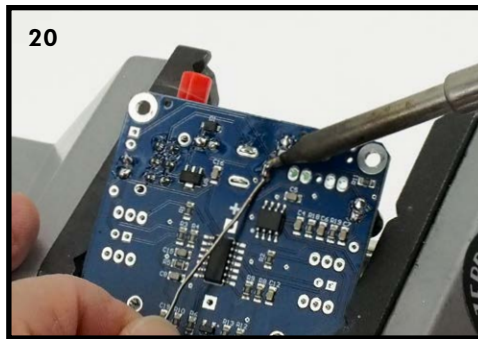
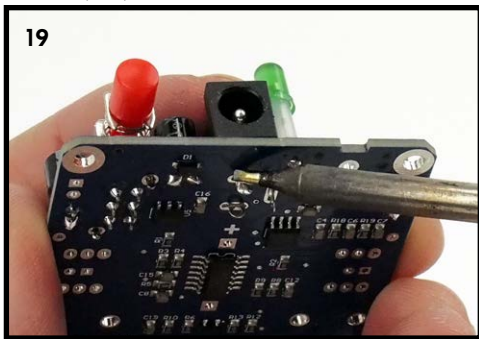

6. Audio Jack: Install the audio jack at J1. Once again, use the tack-in method to install this jack (21). Once the jack is held in place, finish soldering the rest of the pins (22). Remember to re-flow the tacked in pin.

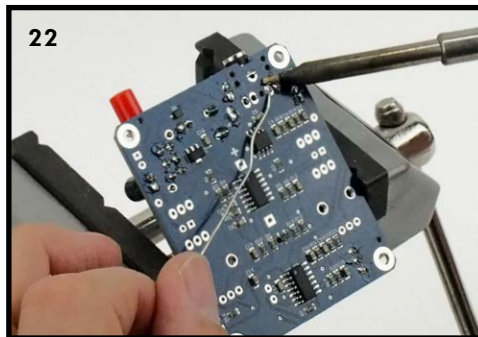
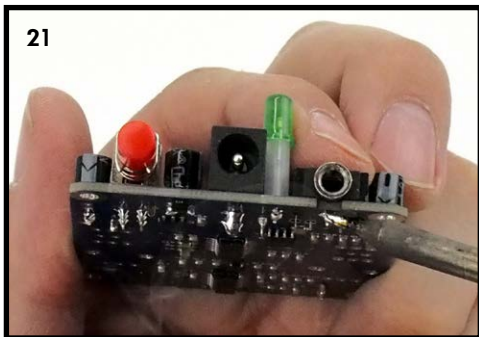

7. LDRs: As mentioned in the How It Works section, LDR stands for light dependent resistor and they are used as the volume and pitch light sensors in the Noisette.

Your Noisette kit contains three LDRs. They have each been hand selected to have the correct resistance range needed for their particular use in the Noisette. You will notice that one of these LDRs has black dot on its backside. Set aside this LDR with the dot because it will be used for the optocoupler, which we will assemble later. For now, we will be installing the two LDRs without black dots.

In this application, the body of each LDR is held 21mm above the circuit board, which allows it to reside inside the LDR shield. We will use a piece of 2mm heat shrink tubing to space the LDR the proper distance above the PCB. Cut two pieces of 2mm heat shrink, 21mm in length. Basically, just cut the ~42mm long piece of heat shrink in two equal pieces (24). They don't have to be exact, they can be off by +/- 1mm.

Place one piece of these pieces onto one leg of one of the LDRs (25). Install it in one of the LDR locations (26); please don't shrink the heat shrink, it is only being used as a spacer. Make sure the LDR is standing up straight, perpendicular to the surface of the circuit board. Also make sure the body of the LDR is sitting on top of the heat shrink. It helps to hold the LDR in place as you tack one leg down (27). Solder both LDRs in place and clip their leads (28,29).

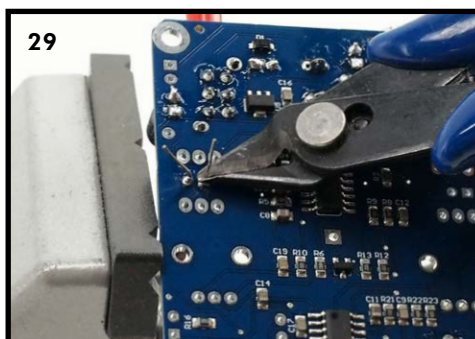
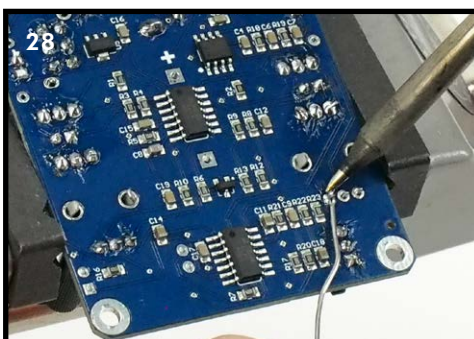
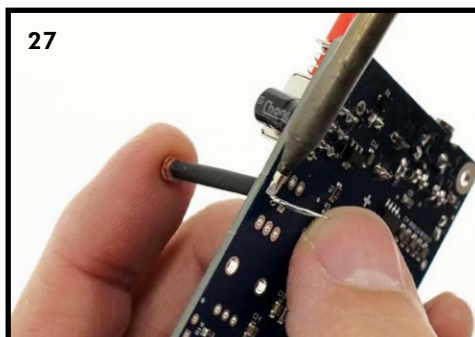
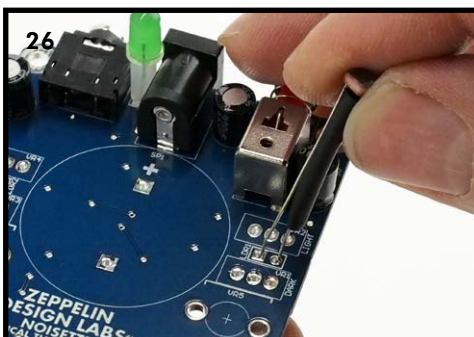
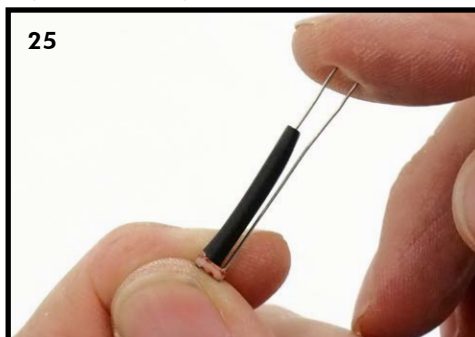

8. Trimmer Potentiometers: The Noisette contains four trimmer potentiometers (trim pots). VR1 – VR4 should fit into their locations with the adjustment screw located toward the right, as in the photo (34).

Use the tack-in method to solder these trim pots in. Hold the pot in place with one finger, apply some solder to the tip of your iron, and then quickly tack in one lead on the bottom of the board (31,32). Make sure the bottom of the trim pot is flush with the top of the board. Remember to re-solder the tacked in lead to make sure it is making a good connection. Solder all four trim pots to the board, then snip the leads (33).

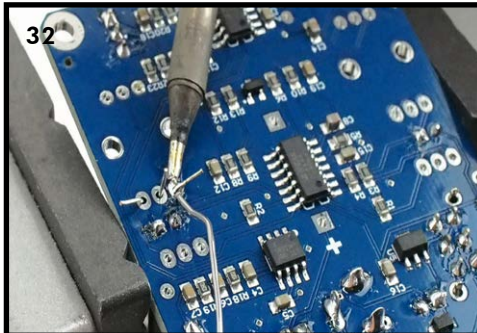
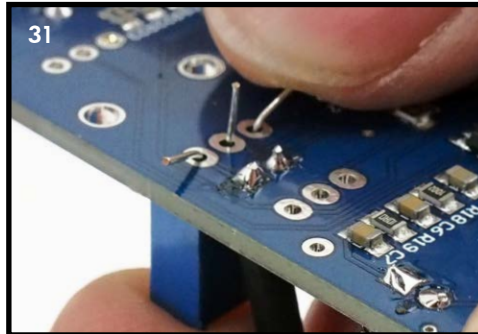
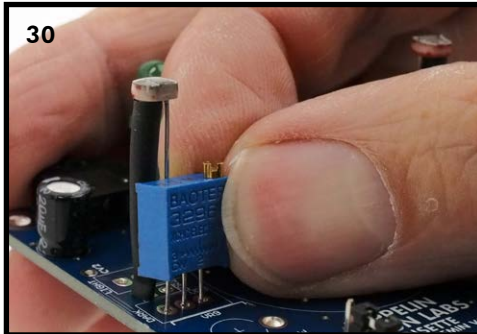

9. Potentiometers: Install the potentiometers (aka “pots”). Make sure they are all seated securely and flush against the PCB; otherwise the completed board won’t fit properly into your Noisette’s case. Double check that the shafts of the pots are all standing at 90 degrees (perpendicular) to the board. When soldering do not use too much heat. If you cannot move quickly with your iron, solder only one pin on each pot, sequentially. This will allow each pot to cool before you solder its next pin. It is only necessary to solder the three small pins on each pot. The two large pins help clip the pot to the PCB and it’s not necessary to solder them to the board (34,35,36,37).



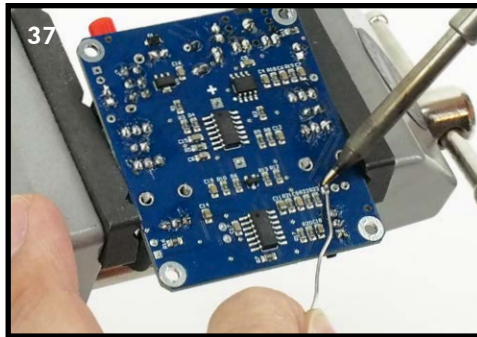
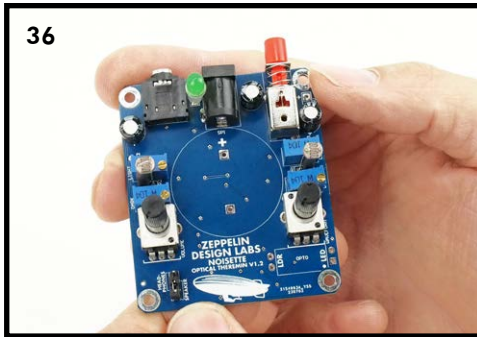

10. Optocoupler: The optocoupler is part of the VCA circuit that controls the volume of the Noisette. It consists of a light dependent resistor (LDR) and a light emitting diode (LED), both of which are sealed inside a length of heat-shrink tubing. In a previous step we set aside the LDR with the black dot on its backside. We will now use this dotted LDR in building the optocoupler. We will first construct the optocoupler and then install it on the board.

- a. Insert the green 5mm LED into the end of a piece of heat-shrink tubing. Proper placement of the LED in the tube is important. Slide the LED into the tube until the back of the LED is about 5mm from the end. The LED just needs to be far enough into the tube so the end can be pinched fully closed around the backside of the LED (38). This will keep as much ambient

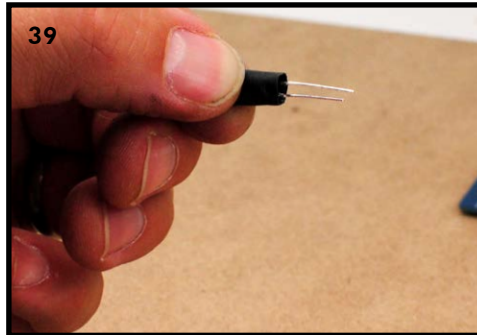
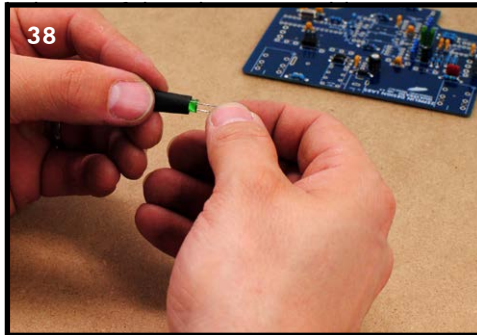

- b. As you hold the LED in this position from the outside of the tube, carefully heat up the end of the tube with your soldering iron until it closes around the LED leads (39,40). Once it has stopped shrinking but while it is still very hot, use your pliers to pinch the shrunken tubing closed around the leads to help seal the opening (41,42).

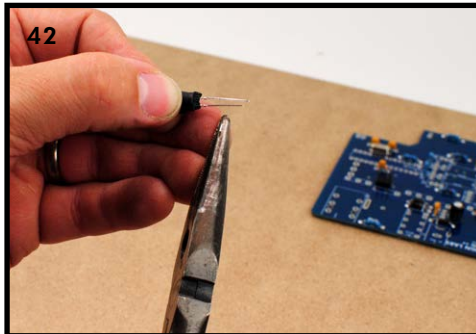
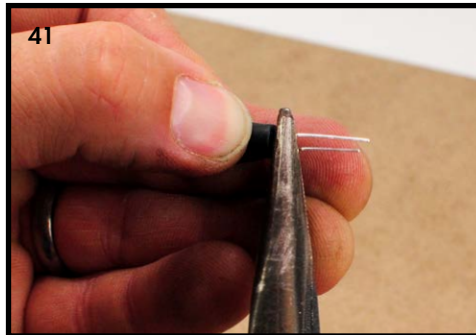

- c. Slide the LDR into the other end of the heat-shrink tubing until it is touching the LED (43). Rotate the LDR so that its leads are on the same plane as the LED leads (44).

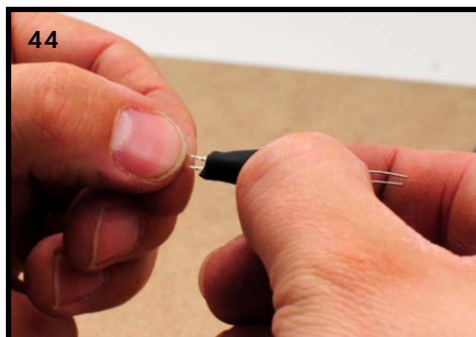
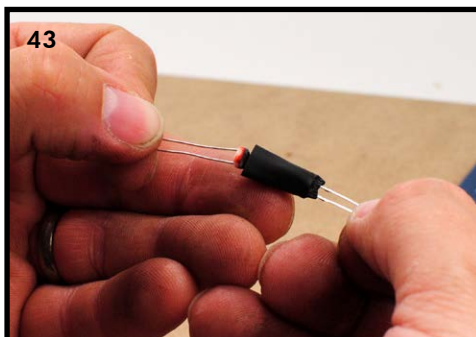

- d. As you hold the LDR from the outside of the heat-shrink, carefully heat this side of the tube until it closes around the LDR leads (45,46). While it is still very hot, use your pliers to pinch the end closed around the LDR leads (47).

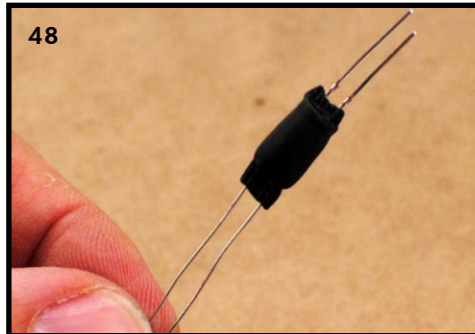
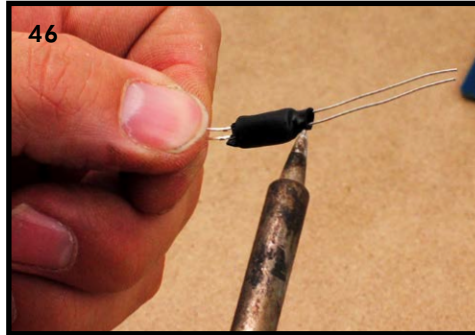

Now that we've made the optocoupler, we can install it. The leads need to be bent 90 degrees, but it matters which way you bend them in order for them to fit on the board in the proper orientation (remember, LEDs are polarized). If you put the opto in backwards the volume sensor will not have any effect. Note the PCB graphics indicate where the LDR and LED are intended to go. On your optocoupler, the LED has one long lead and one short lead. The long lead of the LED goes into the hole with the square pad. Note which side of the optocoupler needs to be up as you bend the leads down in order for it to fit into the holes properly. Grip the leads with your needle nose pliers as shown (48) and bend them down 90 degrees with your fingers (49). Bend the LDR's leads in the same way, holding with pliers and bending with your fingers (50).

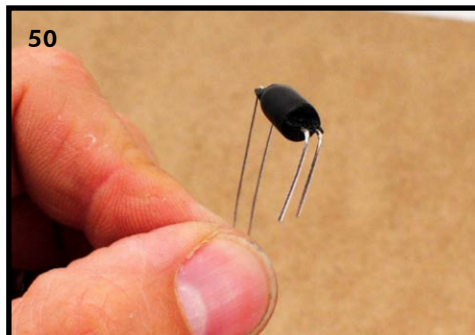
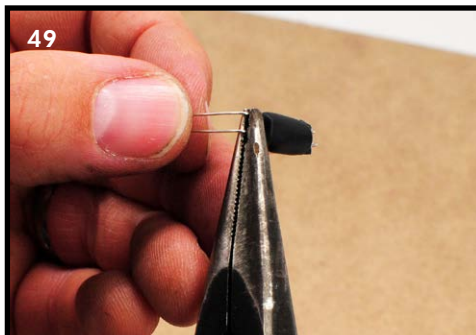

- e. Carefully install the optocoupler on the PCB. Double check to make sure the long LED lead is in its correct hole – with the square pad (51). Bend the leads out on the back, solder all four leads and snip them (52).

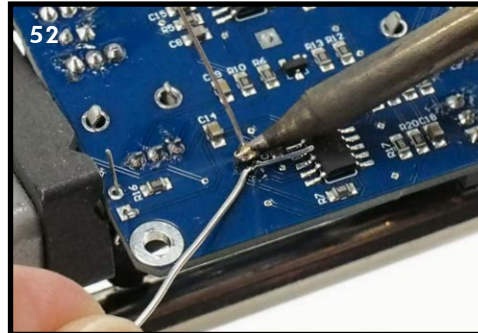
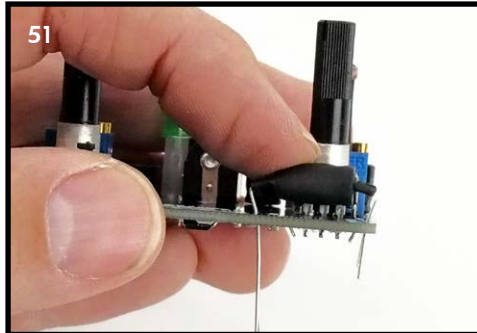

11. Speaker: Place the speaker into its holes (53). The pin marked with a "+" on the bottom of the speaker goes into the hole marked "+" Make sure it's sitting flush to the top of the circuit board, then solder the pins (54). Try not to use an excessive amount of heat on the pins; try not to let the soldering iron tip linger on the pins longer than necessary.

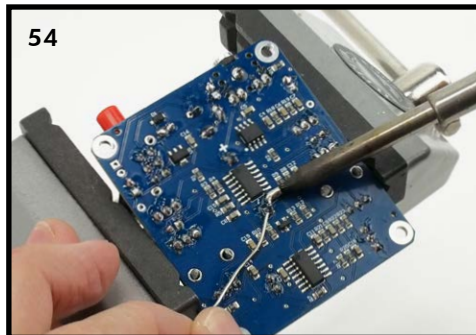

12. Battery Snap: Before we install the battery snap we need to cut the leads to the correct length. The leads need to be 72mm from the plastic snap. Measure with your ruler and cut them that length (56). Then use your wire strippers to strip about 3mm (1/8") of insulation off leads. (57)

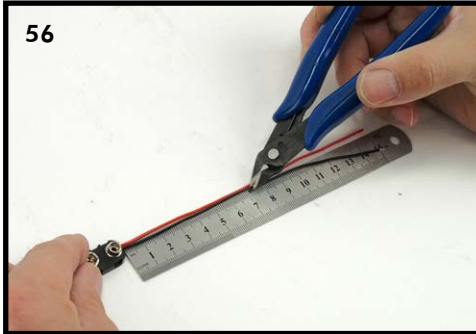

Gently twist the tiny strands of copper wire together. Tin the ends of the wires with your soldering iron (58), which means to add a tiny bit of solder to the wire to help hold the strands of wire together. Make sure you don't add too much solder otherwise the wire won't fit into the circuit board holes. Now solder the wires to the 9V port on the PCB (59,60). The red wire goes in the square hole and the black wire goes in the round hole...DO NOT MIX THEM UP!

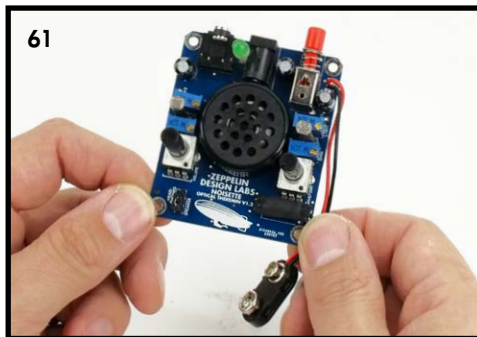
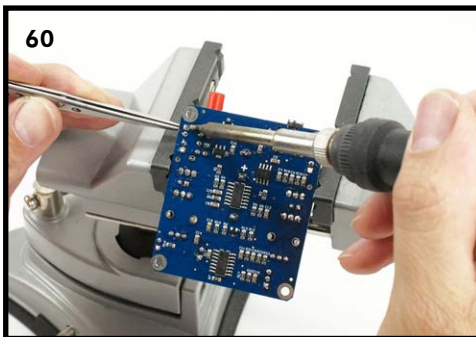
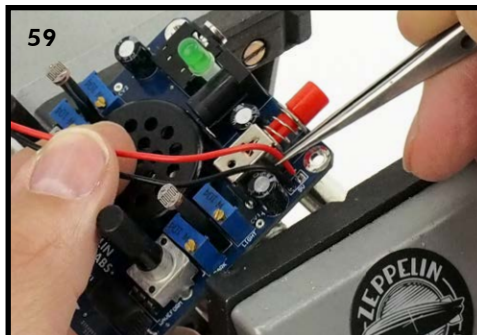
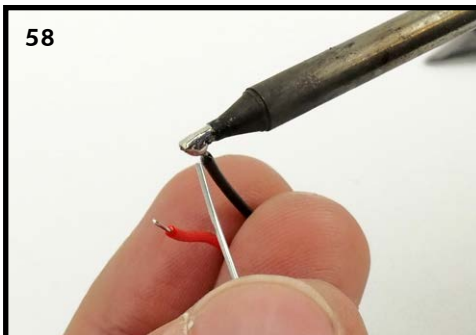

13. Hex Standoffs: Use a #2 Phillips screwdriver and the M3x6 screws to screw the hex standoffs to the two lower holes on the board (62-64).

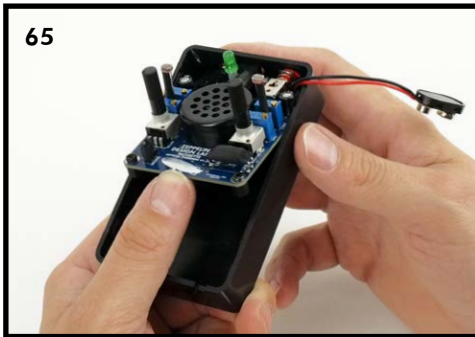
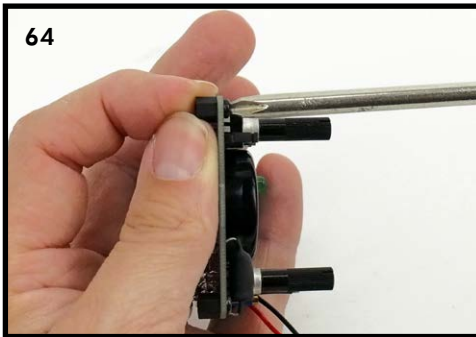
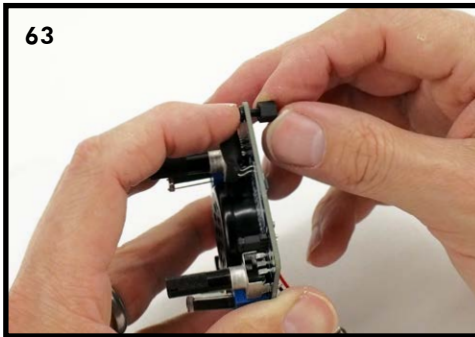
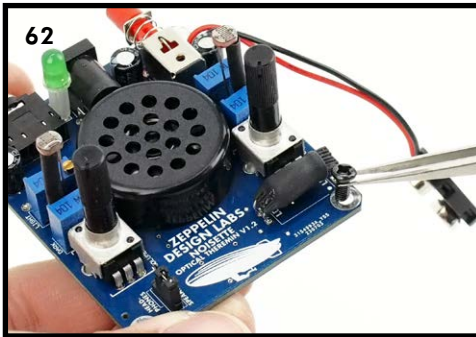

Slide the circuit board into the box by lining up the jacks and power switch to their holes in the box (65). Screw the PCB onto the box's standoffs with the two tiny M2.5x5 screws (66). You will need to use a #1 Phillips screwdriver with these screws.

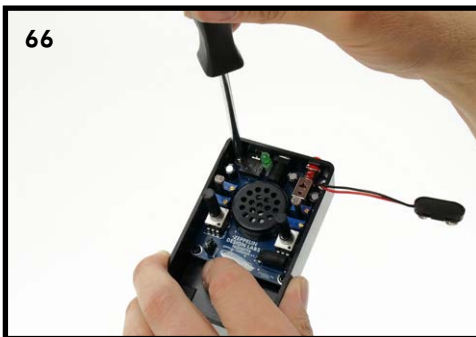

Use hot glue or a very small amount of super glue gel to hold the hex standoffs to the base of the case (67). Do not put any glue under the standoffs, just apply glue to the junction of where each standoff is touching the base.

Don't use too much glue, and make sure you DO NOT glue the circuit board to the standoff! The idea is that if you ever need to remove the circuit board, you'll just need to remove the screws, while the standoffs remain glued to the case.

Note: If you used super glue gel, please wait until the glue has completely dried before continuing with the next step. The battery can easily and inadvertently get glued inside the case. Also, super glue vapors can leave a nasty white residue on things in its proximity while it is drying.

14. Calibration: In calibrating the LDRs in the Noisette, you'll need to measure the DC voltage on the CV pads (CV1 and CV2) while turning a trim pot with your small screwdriver. One trim pot will be adjusted while the sensor is in the dark and the other trim pot will be adjusted for the light. This means the red probe of your meter should touch the CV point while the black probe should touch a ground point on the board. An easy ground point to reach is the metal pin on the top of the headphone jack (70). The process involves covering the LDR to keep out the light, holding the multimeter test probes in the proper place, and turning a trim pot, all at the same time. It can be kind of cumbersome to do all these things at once, so you may need to get an assistant to help you with a couple of them.

Please keep in mind, the specific calibration voltages in this manual are intended as starting points. You'll eventually need to adjust them to your own liking, depending on how you want to play your Noisette.

Power on the Noisette by either using a 9 volt battery or a 9 volt wall adapter (available from Zeppelin Design Labs) (68). Make sure you tuck the battery snap wires down between the edge of the case and the trim pots to keep them out of the way when we install the lid in a later step (69). If you are using a wall adapter, please make sure it has the proper voltage and polarity on the jack. A minimum of 50mA is needed.

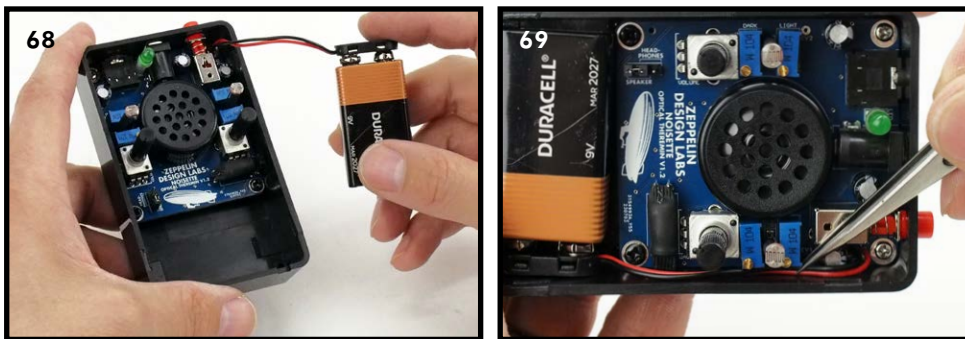

Turn the volume knob all the way counter clockwise, so you don't have to listen to the Noisette while you make these adjustments.

We'll calibrate the volume sensor for the dark first: Place the LDR shield over the left (volume) LDR (71). Cover the top of the LDR shield with your finger (blocking the light from getting to the LDR), while you measure CV2 with the multimeter (72). Turn the trim pot labeled "dark" until the voltage on CV2 reads just under 1.8 volts. You'll probably need to turn the trim pot in the counter-clockwise direction several full spins before you see any movement of the voltage. These trim pots are 25 turn pots, so it takes 25 full turns to reach their full resistance. It might take a while of turning before you get to the proper voltage. If you turn it at least 25 times without seeing any movement, try turning it the other direction for a while.

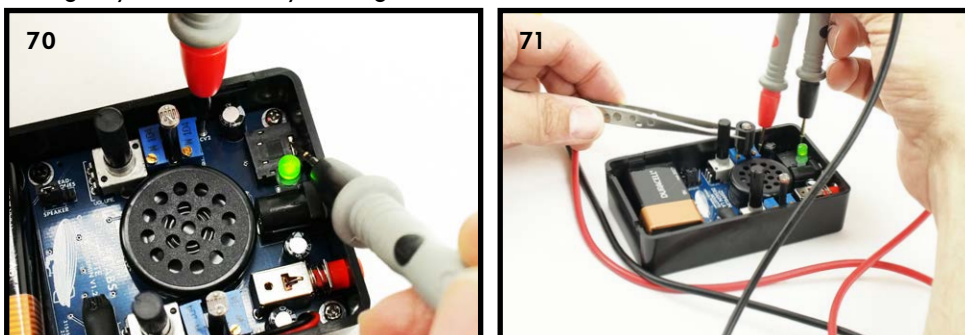

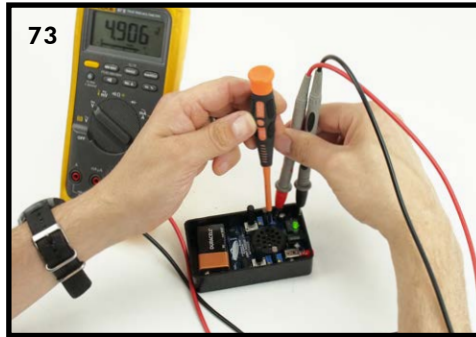

Next, we'll calibrate the volume sensor for the light. Remove the shield from the LDR. Keep the meter probes in the same locations. While the LDR is in the light, the voltage on CV2 should be just under 4.9 volts, so adjust the trim pot labeled "light" until so you read this voltage at the test point (73). It may take turning the trim pot several times in the counter-clockwise direction to get this voltage. Now the volume control sensor should be calibrated. When you cover the sensor with your hand, the Noisette's LED should be dark and when you move your hand to let the light shine on the sensor, the LED should be bright.

Now we can calibrate the pitch sensor. We'll do this the same way that we calibrated the volume sensor. First, we'll calibrate it for the dark. Place the LDR shield on the LDR and put the red probe on the CV1 test point. Keep the black probe in the same location on headphone jack. While keeping your finger mostly covering the LDR, turn the "dark" trim pot until the voltage on CV1 reads no higher than around .8 volts. Counter-clockwise increases the voltage and clockwise decreases the voltage. Once again, you may need to turn this pot lots of times until you see any change in voltage. If the voltage never changes, then try turning it the other direction multiple times.

Finally, we'll calibrate the pitch sensor for the light. Keep the LDR shield and the probes in the same place, but don't cover the LDR with anything. Adjust the "light" trim pot until the voltage on CV1 reads just under 5 volts or so. Counter-clockwise for more voltage and clockwise for less voltage.

SOME THEORY IN SETTING THE TRIM POTS

Once again, these trim pot settings are intended as starting points, just to get your Noisette working for you. We encourage you to play around with the settings until you've found something that works best for you and how you like to play. For the most accuracy in pitch and volume, you'll need to adjust the sensor calibration for the widest range of hand motion.

It's important to do the calibration routine in the type of ambient light conditions that you intend to use your Noisette, otherwise the dynamic range of the sensors will be greatly limited. The idea is to use the brightest light that you expect the Noisette will ever see to calibrate the "light" trim pot, and the darkest conditions that the Noisette will ever see to help calibrate the "dark" trim pot. If you plan to play your Noisette with your fingers, please keep in mind that fingers are somewhat translucent (they allow some light through), so consider that when calibrating for dark conditions.

For the CV1 (pitch sensor), it's generally best to have the widest range of voltage as possible, corresponding to the widest range of light the pitch sensor will ever see. The voltage limit on the upper end of that range is 5 volts, so in a very bright environment, try to adjust the "light" trim

pot until it is as close to 5 volts as possible, without actually reaching 5 volts. Keep in mind, if you end up using your Noisette in an environment that is brighter than the room you calibrated it in, the pitch won't get any higher than when CV1 is at 5 volts. So if you plan on using your Noisette in different environments you may want to give the "light" setting a bit of headroom by setting it lower than 5 volts.

The "dark" voltage setting of CV1 (pitch sensor) should be as low as practically possible. You'll notice that if you adjust the "dark" trim pot too low (while the sensor is in the dark), the voltage of CV1 will not raise up to 5 volts when it is in the light. So then you'll have to re-adjust the "light" trim pot to make up for it, but there is a limit to how high you can adjust it when the "dark" trim pot is set very low. So it becomes an iterative process of going back and forth between adjusting the "dark" trim pot (while the sensor is covered) and then adjusting the "light" trim pot in a bright environment until a suitably wide voltage / pitch range is reached.

For the CV2 voltage (volume sensor), the VCA circuit is controlling an LED that only starts turning on at 1.8 volts. So the lowest voltage CV2 needs to be set to (in the darkest condition) is just below 1.8 volts. The LED will continue getting brighter as the voltage is increased, so the maximum voltage CV2 should be (while in the brightest light) is 5 volts. Once again, if you calibrate your Noisette to 5 volts in a moderately bright environment, it will not get any louder in a brighter environment. So you may want to build in some headroom by setting the bright CV2 voltage to something lower than 5 volts.

One other note to be mindful of is that you may need to readjust these settings to accommodate how the LDRs fit in the LDR shields once the lid is in place on the Noisette. The LDR shields tend to block more light when they are installed in the lid, as opposed to just being placed over the LDRs when you calibrate them. So it may be helpful to set the calibration voltages slightly higher than where you actually want them, so when the assembled lid is installed on the Noisette, causing the LDRs to receive less light than the calibration conditions, the voltages will be closer to where you want them.

15. Speaker Grille: Rotate the speaker grille in its hole on the lid so that the grille holes are in a pleasing arrangement to you (75). While holding it in that position with your finger, apply a small amount of super glue gel or hot glue on the back side to hold it in place (76).

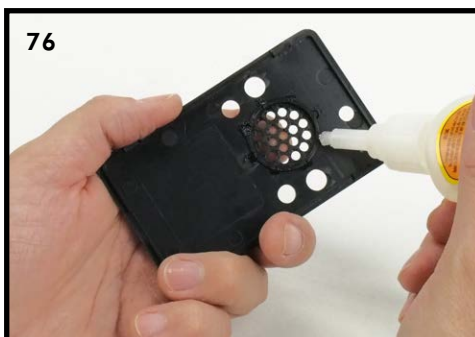

16. LDR Shield: You can install the LDR shields on the lid in the same way as the speaker grille. You'll notice that there is a little groove along the length of one side of the shield. We like to install the shields so that this groove is in the 12:00 position on each one (77), but you can install them in any orientation you'd like. Use the least amount of glue that you need, and don't over-do it (78).



Note: If you used super glue gel, please do not attach the lid on your Noisette until the super glue completely dries, otherwise the vapors from the glue will settle on and stain the circuit board and case, leaving a very hard-to-remove white residue on the parts. In fact, it is a good idea to leave the open Noisette case in an area with lots of air circulation (like in front of a fan) to keep the glue vapors from settling on the black case and PCB. How quick the glue dries depends on how much was used.

Once the glue has completely dried, place lid on box. To do this, line up the knobs and sensors to their holes in the lid. Place the tabs on one side of the lid in their slots (80). Then very gently press down the other side of the lid until it snaps into place (81). Be very careful to not force the lid on, otherwise the tabs may break off of the lid.



That's it! You are now ready to enjoy the crazy sounds of your Noisette!

USING YOUR NOISETTE

Figure 4: Noisette Features and Parts

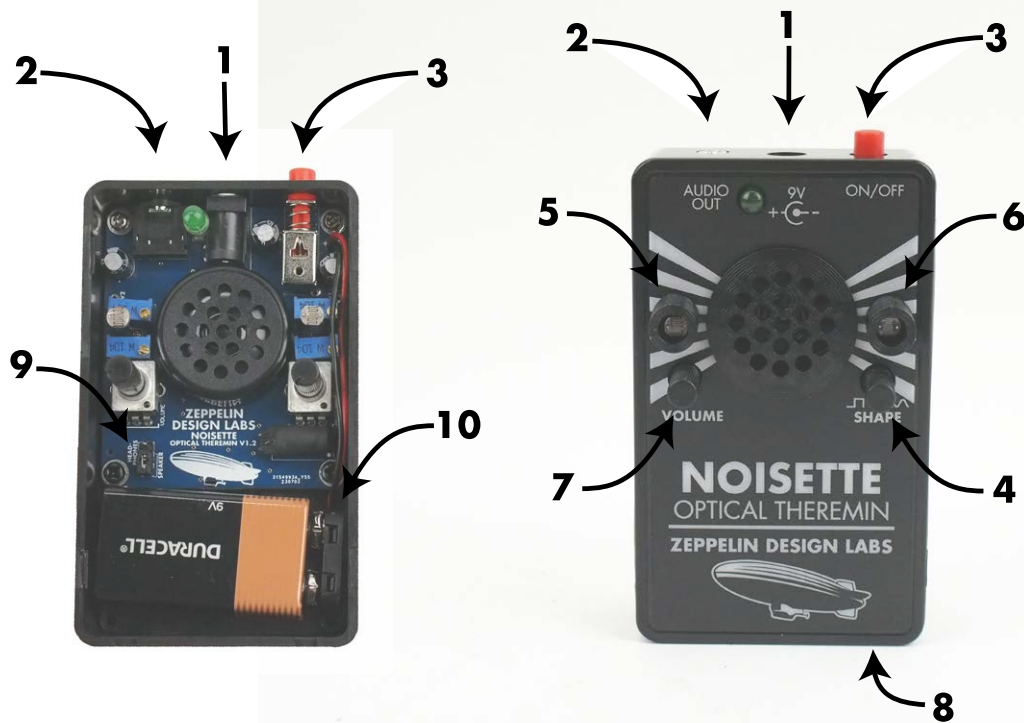

1. DC POWER JACK: An option for applying power to your Noisette is to use a 9 volt, center negative power supply. A typical guitar pedal power supply will work. 50mA minimum.
2. AUDIO OUT JACK: This jack can be used with headphones or as a line output.
WARNING: MAKE SURE THE VOLUME KNOB IS FULLY COUNTERCLOCKWISE (VOLUME VERY LOW) BEFORE USING THIS JACK. LOUD AUDIO SIGNALS MAY CAUSE HEARING DAMAGE.
Please make sure the HEADPHONE/SPEAKER HEADER is in the headphone position, otherwise hearing or headphone damage may occur. If a line level output is desired set the VOLUME KNOB at about the 10 o'clock position and adjust it from there for the desired volume level.
3. POWER SWITCH: When the switch is pressed in the Noisette is on, when the switch is out the Noisette is off.
4. SHAPE KNOB: Controls the Noisette's waveform shape. Pan between square wave (fully counterclockwise) and sine wave (fully clockwise).

5. **VOLUME SENSOR:** Determines the voltage applied to the internal VCA (voltage controlled amplifier). The volume gets louder as more light is detected. The output volume range is limited by the **VOLUME KNOB** setting, and also how this sensor is calibrated (see "Calibration" on page 22).
6. **PITCH SENSOR:** Determines the voltage applied to the internal VCO (voltage controlled oscillator). The pitch frequency ranges from under 20Hz (in complete darkness) to above 3kHz in very bright light, but this all depends on how this sensor is calibrated (see "Calibration" on page 22).
7. **VOLUME KNOB:** Sets the maximum audio volume the Noisette will produce. To be used in conjunction with the volume sensor. See **VOLUME SENSOR** for more information.
8. **CASE LID:** The Noisette case lid can be removed by inserting a flat head screwdriver in the inset at the end of the case and gently twisting until the end of the cover snaps up. Then place the screwdriver on the edge of the case (between the lid and the base) and gently twist until one side of the top lifts. You'll need to remove the lid to access the **BATTERY SNAP** and the **HEADPHONE/SPEAKER HEADER**.
To reattach the cover, line up the knobs and sensors to their holes in the lid. Place the tabs on one side of the lid in their slots. Then very gently press down the other side of the lid until it snaps into place. Be very care to not force the lid on, otherwise the tabs may break off of the lid.
9. **HEADPHONE/SPEAKER HEADER:** Sets the relative output volume level to headphone/line level or internal speaker level.
WARNING: PLEASE MAKE SURE THIS HEADER IS SET TO THE HEADPHONE POSITION WHEN USING THE HEADPHONE OUTPUT. OTHERWISE THE OUTPUT VOLUME LEVEL COULD DAMAGE YOUR HEARING OR EVEN YOUR AUDIO EQUIPMENT.
10. **BATTERY SNAP:** As an alternative to powering the Noisette with the **DC POWER JACK**, you can use a 9-volt battery. Plug the battery into the snap and place the battery in the space at the base of the circuit board.

PLAYING YOUR NOISETTE



Apply power to your Noisette either by attaching a 9 volt battery to the battery snap or by using a 9 volt (center negative) power adapter (the same type of power supply a typical guitar pedal uses).

If you want to use the internal speaker, move the jumper on the internal circuit board header to the SPEAKER position. If you want to use the headphones or line out jack, move the jumper to the HEADPHONES position. Be careful not to use the headphone output while the jumper is in the SPEAKER position because the signal will be very loud and could damage your ears, and possibly your headphones!

The Noisette uses two light sensors to control pitch (right side sensor) and volume level (left side sensor). You can partially cover these sensors with your fingers or hands to alter these parameters. The more light the sensors detect will cause the theremin to produce a higher frequency and louder volume output. The less light the sensors detect will cause the theremin to produce a lower frequency and quieter volume output, to the point of turning off the sound entirely, and perhaps creating lower frequencies than your speaker or headphones can reproduce. Please note, the ambient light level around the theremin will have a significant role in the sensor's dynamic range, meaning the brighter the environment is, the louder the theremin can get, and the higher frequencies it can make. The set calibration points have a lot to do with how the Noisette responds to relative light levels. Please feel free to experiment in environments with different types of lighting and different calibration points (see page 22 for calibration information). It's also fun to experiment with flashlights or other light sources. Most importantly, be creative and have fun with your Noisette!

SCHEMATIC

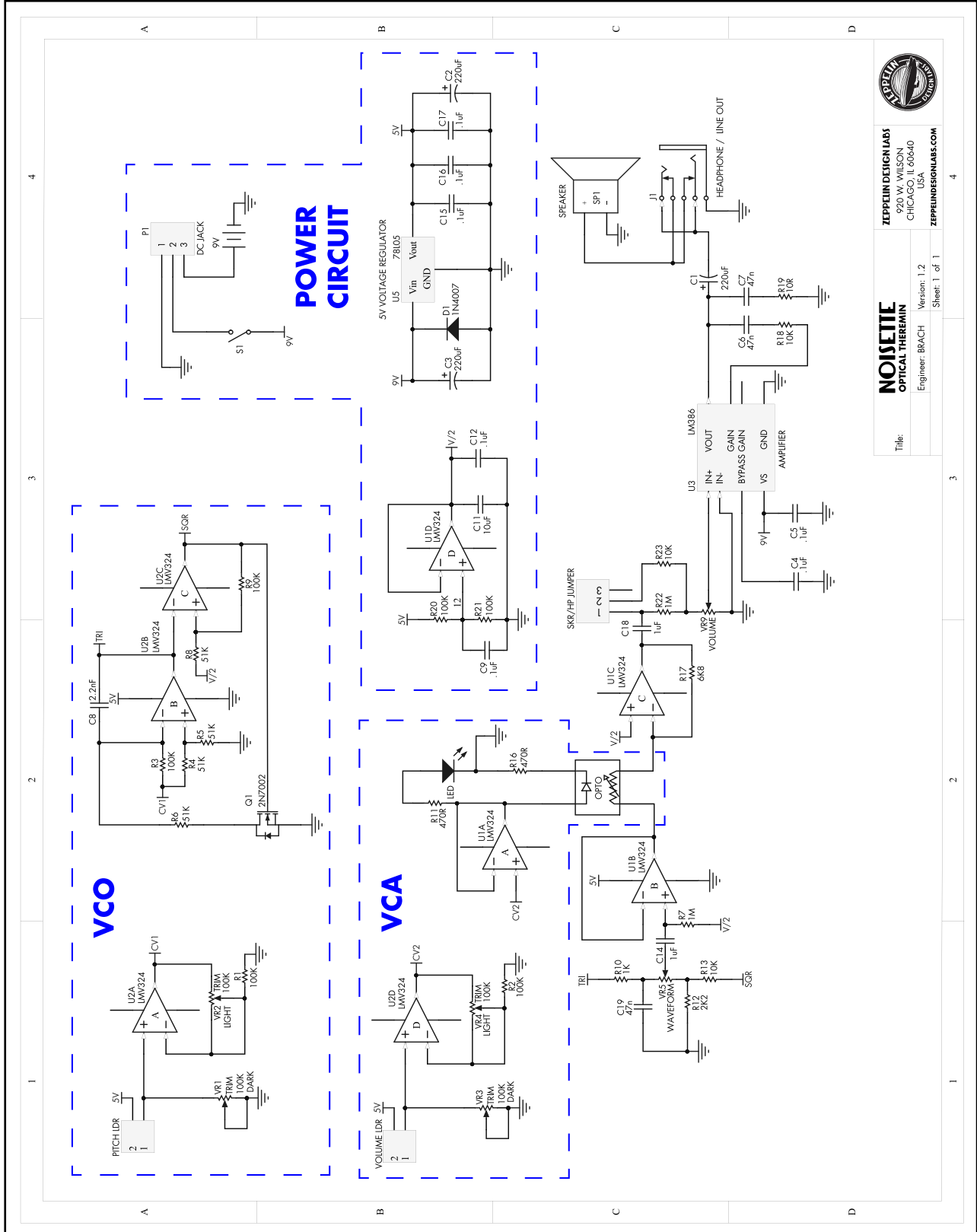

NOISETTE
OPTICAL THEREMIN

Version: 1.2
Engineer: BRACH
Sheet: 1 of 1

ZEPPEIN DESIGN LABS
970 W. WILSON
CHICAGO, IL 60640
USA
ZEPPEINDESIGNLABS.COM

